

# OWNER'S MANUAL

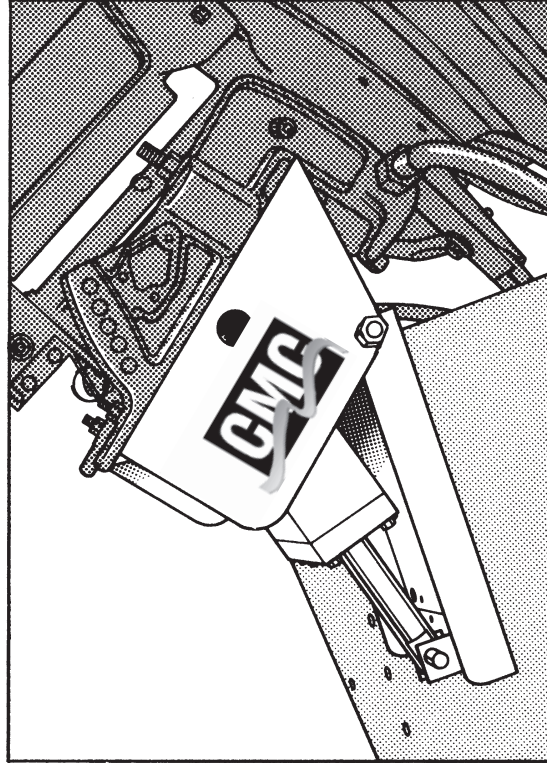

## MODEL PT-35 POWER TILT & TRIM



**COOK  
MANUFACTURING CORPORATION**

CE

© COPYRIGHT - 2006 Part #52160 REVISION 5

## **FOREWORD**

Thank you for choosing a CMC product. This manual is designed to aid in installation and maintenance of your PT-35 Power Tilt and Trim. Each part of the CMC PT-35 is machined from the highest quality material to ensure many years of trouble free service. Computer aided design and precision machining of the PT-35 is done totally at our facility, so you can be sure you have purchased the best quality unit on the market.

## **CONTENTS**

Foreword .....	Inside Front Cover
Installation .....	Page 1
Mounting To Transom .....	Page 2
Mounting Outboard With Clamps .....	Page 2
Mounting Outboard Without Clamps .....	Page 3
Warranty Card .....	Centerfold
Connecting To Power Source .....	Page 4
Servicing .....	Page 5
Actuator Removal .....	Page 6
Emergency Relief Valve .....	Page 6
Parts List .....	Page 7
Troubleshooting .....	Page 8
Warranty .....	Inside Back Cover

## INSTALLATION

Please read the Owner's Manual completely before installing the PT-35. The CMC PT-35 has been predrilled on the transom side to mount to the boat. Be sure to use at least 1/2" diameter stainless steel bolts and nuts for mounting the PT-35 to the boat.

For proper installation the following items should be included in your PT-35 box:

1. One hydraulic PT-35 unit.
2. One wire assembly with toggle switch.
3. One switch plate and rubber boot.

Step 1: Consult the outboard motor manual for the proper motor lifting procedures. You will need to lift the motor in some fashion with a lifting device rated at the proper lifting capacity.

Step 2: Attach the lifting device to the motor making sure the motor is supported safely.

Step 3: Remove the fasteners that mount the motor to the transom of the boat.

Step 4: Swing the motor away from the transom of the boat taking care not to damage any wires or cables (Fig. 1).

The figures below show the transom view (Fig. 2) and the motor view (Fig. 3) of the PT-35. The transom view to be mounted to the transom and the motor view to the motor.



Fig. 1

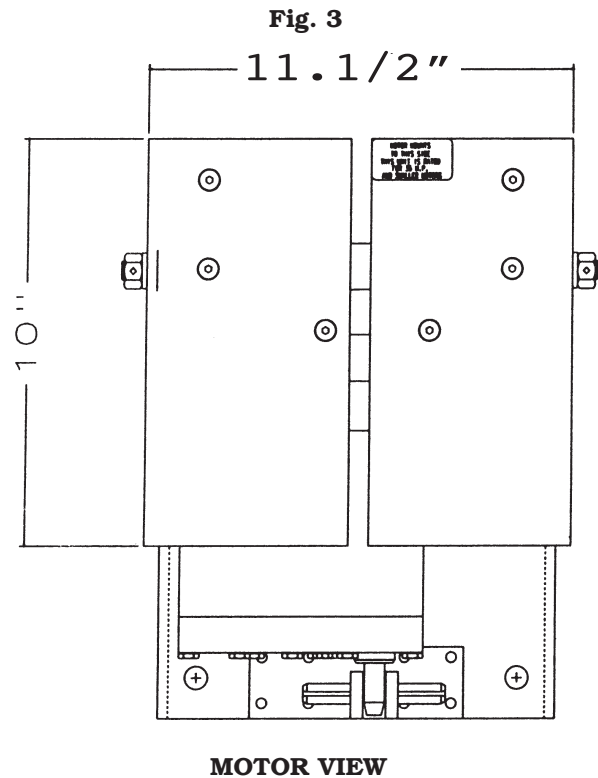
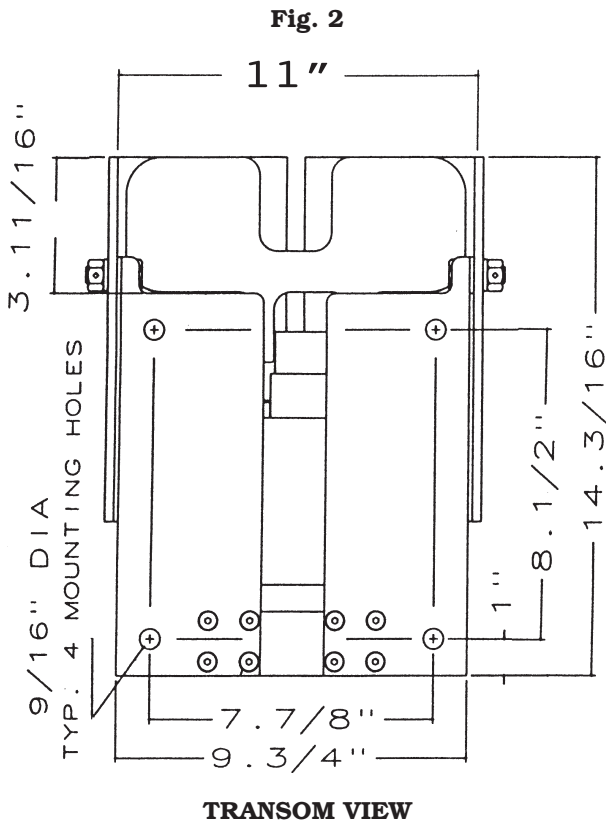

## MOUNTING THE PT-35 POWER TILT & TRIM TO THE TRANSOM OF THE BOAT

When mounting your motor, take into consideration that your motor will set back away from the transom 5 1/2 inches. This allows you to mount your motor higher than you can when it is mounted to the transom (because as the water passes under the transom it comes up toward the propeller when it is set back 5 1/2 inches). When mounting the motor on the PT-35, the cavitation plate of your motor should be 1 to 3 inches above the bottom of the boat for best performance results.

**NOTE: If you have a lightweight boat and cavitation occurs at the prop when you walk from the stern to the bow, you might consider distributing the weight in the boat toward the back.**

Step 5: Fill in any motor mounting holes in the transom with silicone rubber sealant. Drill four holes into the transom to match the four predrilled holes that are on the transom side of the tilt and trim (Fig. 4). When drilling the holes, make sure that the top of the transom side of the PT-35 will be approximately 1" above the top of the transom and that it is centered on the transom as shown in Fig. 6.

**NOTE: To make the mounting holes more accessible, follow the instructions on page 4 to obtain power to the PT-35. Tilt the PT-35 up to allow access to the mounting holes.**

Step 6: Use at least 1/2" stainless steel bolts to mount the PT-35 to the transom. To ensure proper clearance, insert the mounting bolts from the inside of the PT-35 out (the head of the bolt inside of the PT-35 and the nut and washers on the inside of the boat). Fasten the unit to the transom, making sure to use flat washer and lock washer before the nut (Fig. 5 & 6). These bolts should be checked for tightness frequently.

## MOUNTING AN OUTBOARD MOTOR WITH TRANSOM CLAMPS TO THE PT-35

Step 7: Set your motor onto the PT-35 and center it. (If your motor is mounted with four bolts through the transom and does not have transom clamps, go to Step 10. Tighten the clamps down as shown in Fig 7.

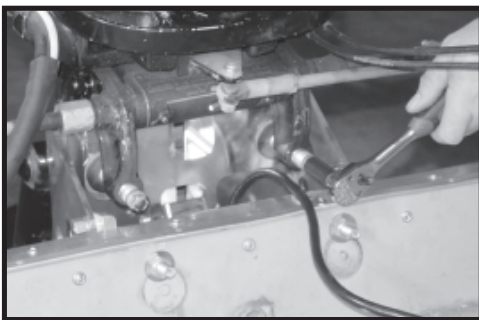

Fig. 7



Fig. 4



Fig. 5

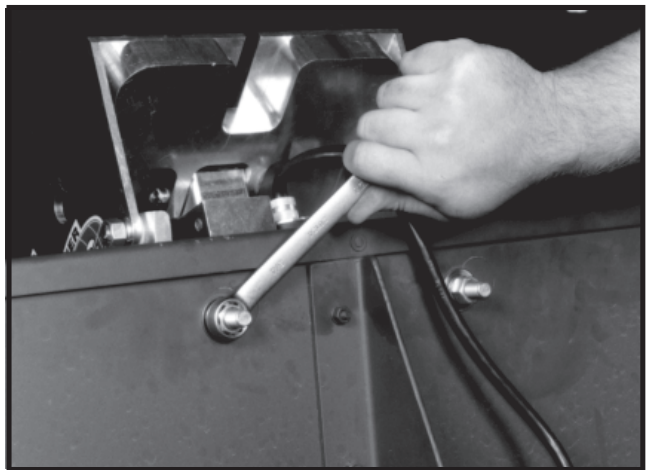

Fig. 6



Step 8: If your motor has two mounting bolts at the bottom, using the mounting holes as a template, drill through the PT-35 as shown in fig. 8.

**CAUTION: SO THAT YOU WILL NOT ACCIDENTALLY DRILL INTO THE ACTUATOR, TILT THE PT-35 AS SHOWN IN Fig 8.**

Step 9: Use at least 1/2" stainless steel bolts to mount the motor to the PT-35. To ensure proper clearance, insert the motor mounting bolts from the inside out (the head of the bolt inside of the PT-35 and the nut, flat washer and lock washer on the outside). Tighten the bolts. These should be checked frequently for tightness (Fig. 9).

**CAUTION: When you run your boat for the first time after you have installed the PT-35, make sure that you have plenty of water pressure at top end speed. If the water pressure is less than it was before the PT-35 was installed, lower the motor.**

**NOTE: The PT-35 has a total of 84 degrees of tilt and trim. Some motors will not be able to tilt the full 84 degrees without the cowling or motor clamps interfering with the transom of the boat. Exercise caution when tilting to see if there are any limitations. Most steering cables have plenty of extra length to install the motor to the PT-35 without disconnecting them. However, some models may require longer steering cables.**

### **MOUNTING AN OUTBOARD MOTOR THAT DOES NOT HAVE TRANSOM CLAMPS**

Step 10: Set the motor onto the PT-35 and center it. Using the motor as a template, mark the location of the required top two holes to be drilled for mounting the motor. Drill the holes at the top first and mount the motor using at least 1/2" stainless steel bolts, To ensure proper clearance, insert the mounting bolts from the inside of the PT-35 out (the head of the bolt inside of the PT-35 and the nut and washers on the outside). Tighten the bolts (Fig. 10). Drill the lower mounting holes using the motor as a template (Fig. 11). When you drill the lower hole on the port side, make sure your tilt the motor enough to eliminate the chance of accidentally drilling into the actuator.

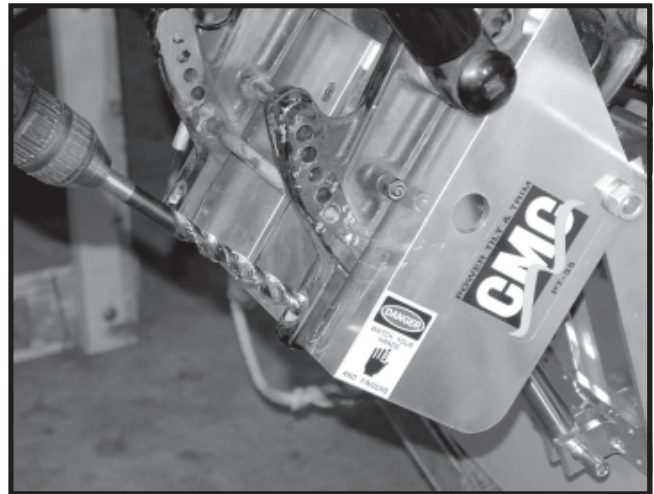

**Fig. 8**

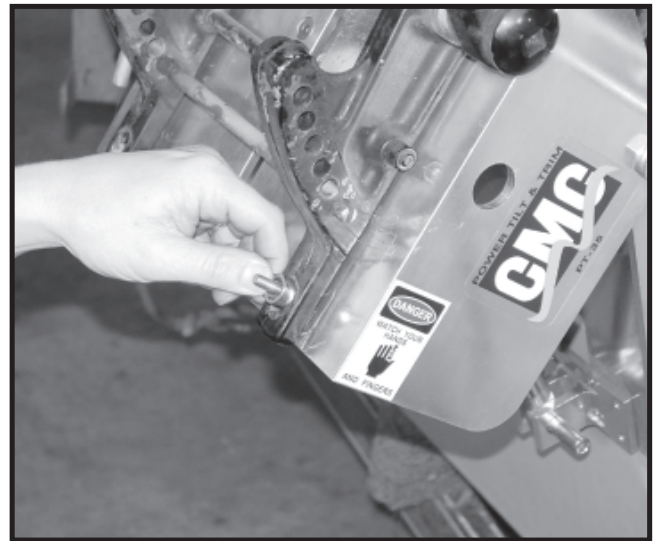

**Fig. 9**

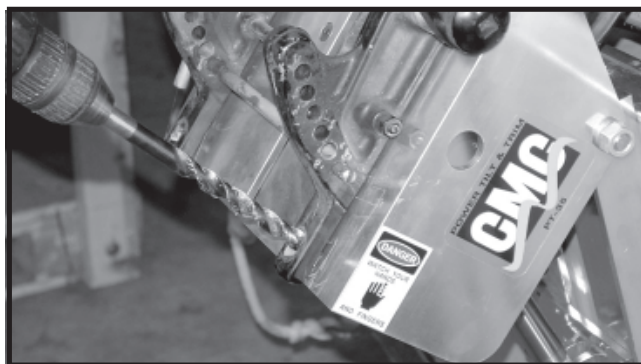

**Fig. 11**



**Fig. 10**

Tighten the lower bolts (Fig. 12). All of the mounting bolts should be checked for tightness frequently.

### CONNECTING TO POWER SOURCE

- Step 11: Find a good location for the up-down toggle switch. This toggle switch should be located for easy access while operating the throttle. Use a 1/2 inch drill to drill a hole at the chosen location taking care not to damage wires or brackets (Fig. 13)
- Step 12: Locate the wires on the wire assemble; 1. One labeled **up**; 2. One labeled **down**; 3. One labeled **12V**. Position the switch so the terminal posts are on the side nearest you. Connect the **down** wire terminal to the **top** post. Connect the 12V wire terminal to the **center** post. Connect the **up** wire terminal to the **bottom** post (Fig. 14).
- Step 13: Push the toggle switch through the 1/2 inch hole that you previously drilled. Place the up-down switch plate and rubber boot with nut on the switch (Fig. 15).
- Step 14: Connect the 2-wire male connector from the hydraulic power unit to the female 2-wire connector at the end of the wire assembly (Fig. 16).

Find a dry location for the two 40 amp relays and secure them there.

**NOTE: If your boat is used in a corrosive environment such as saltwater and you cannot locate a dry place for the relays, you can secure the relays inside the cowling of your engine. Instead of connecting the positive and negative ring terminals of the wire assembly to the battery, connect them to the starter where the positive and negative leads from the battery are attached.**

- Step 15: Connect the ring terminal labeled **POS** to the positive battery terminal and connect the ring terminal labeled **NEG** to the negative battery terminal.

The PT-35 is now ready for operation. When you push the toggle switch lever up, the PT-35 should run up. When you push the switch down, it should run down.

**CAUTION: WHEN TRAILERING IT IS RECOMMENDED TO SUPPORT THE PT-35 WITH A TRANSOM SAVER DEVICE. WHEN RUNNING THE PT-35 DOWN TO THE SUPPORT, JUST MAKE CONTACT WITH IT. DO NOT CONTINUE TO LUG IT DOWN AFTER INITIAL CONTACT HAS BEEN MADE OR DAMAGE TO THE, PT-35 WILL OCCUR.**

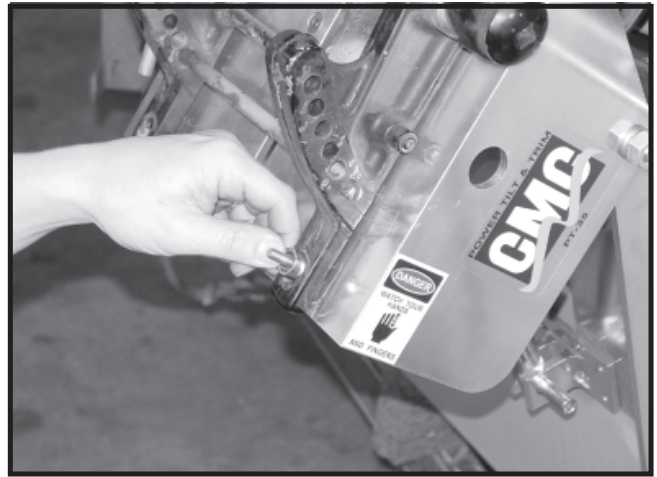

Fig. 12

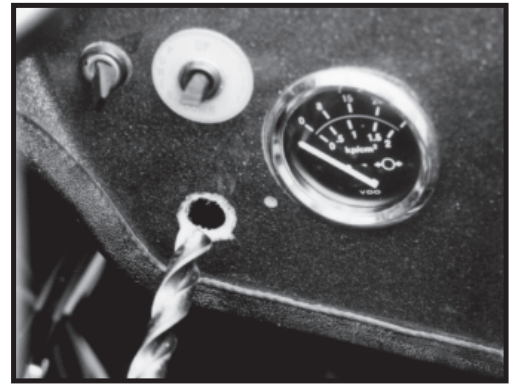

Fig. 13

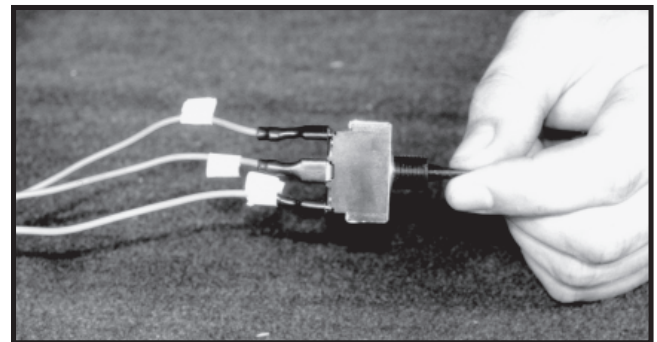

Fig. 14

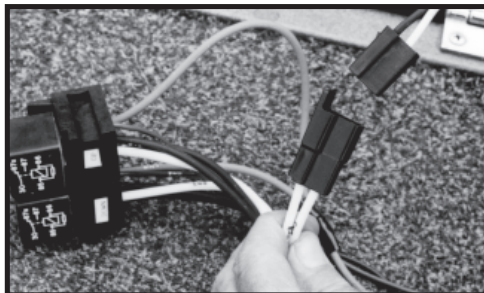

Fig. 16

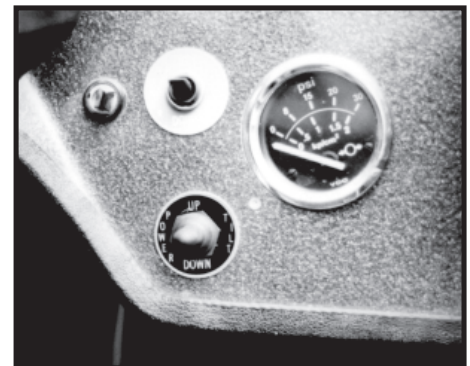

Fig. 15



## SERVICING

Your CMC PT-35 is operated with a hydraulic actuator, which is located inside the unit. It is filled with the correct amount of hydraulic fluid and tested at the factory. If it becomes necessary to add fluid to the actuator, use #2216 Mystic or equivalent, SAE 20 or 30 non-detergent oil. Follow the procedure below for adding fluid and bleeding the system:

First, trim the PT-35 all of the way down. Remove the 1/8" brass socket **filler** plug with a 3/16" hex key wrench (Fig. 17). Next, with the same wrench, remove the level plug. You can access this plug through the lower machined hole on the port side motor rail as shown in Fig. 18. Pour fluid into the actuator through the **filler** hole until fluid runs out of the **level** hole on the side of the actuator (Fig. 19). Run the actuator until the ram is fully extended and the motor bogs down (the PT-35 is all the way up). Then retract the ram completely until the motor bogs down (trim the PT-35 all the way down). Replace the **level** plug (Fig. 20). Tilt the PT-35 out until the ram is extended 2 to 3 inches out of the actuator (Fig. 21).

Replace the filler plug.

If preferred, the above procedure can be executed with the actuator completely removed from the PT-35. Please see the next page for the removal of the actuator.

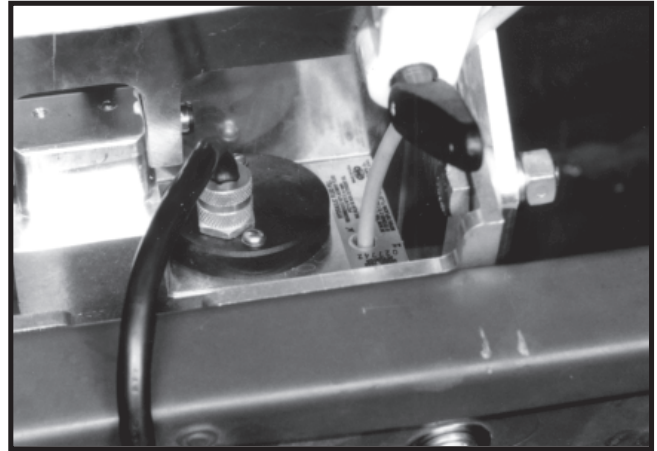

Fig. 19

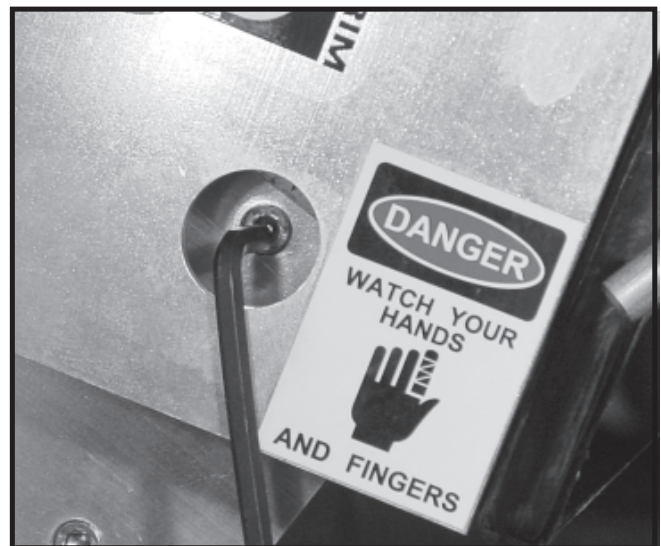

Fig. 20

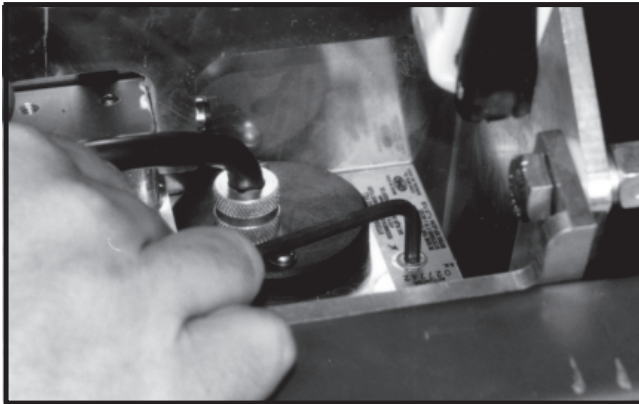

Fig. 17



Fig. 18



Fig. 21

## ACTUATOR REMOVAL

There are holes machined in the port and starboard motor rails to allow easy access with a 1/2" to 7/16" diameter punch or driver bar for removal of the two actuator spring pins. One spring pin is located at the top of the actuator and the other is located at the bottom of the ram.

Trim the PT-35 down. Follow the electrical cordset from the motor of the actuator into the boat approximately 6 ft. to a male to female connection, Disconnect it there. Next, drive the spring pin at the bottom of the ram out with your punch or driver bar (Fig. 22). Then, insert the driver bar or punch through the machined hole on the port or starboard motor rail to the spring pin at the top of the actuator and drive the pin out (Fig. 23 & 24). Remove the actuator from the bottom of the PT-35 (Fig. 25).

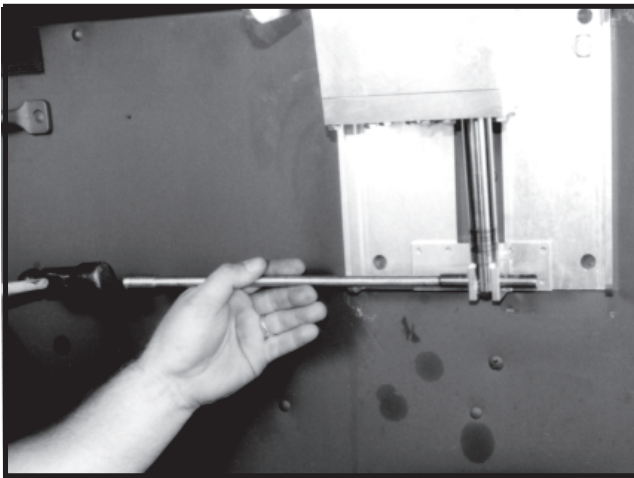

Fig. 22



Fig. 23

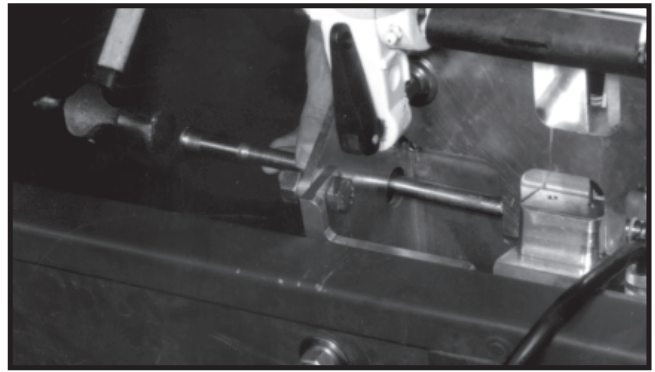

Fig. 24

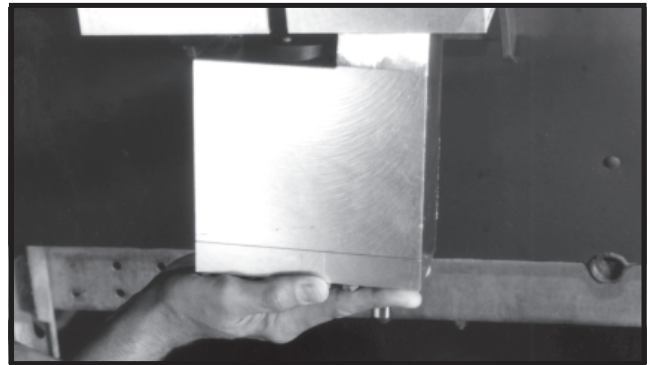

Fig. 25

## EMERGENCY RELIEF VALVE

Your PT-35 actuator features a pressure relief valve that will allow you to manually raise or lower the tilt & trim unit if it becomes necessary due to power loss or actuator malfunction. This pressure relief valve is a 1/4 hex screw head located at the bottom of the actuator toward the port side (Fig. 26). Gradually turn the relief valve counter clockwise 1/2 to 1 full turn (NO MORE THAN 1 FULL TURN). This will allow you to manually raise or lower the PT-35.

**CAUTION: IF THE PT-35 IS IN THE UP POSITION WHEN IT BECOMES NECESSARY TO RELIEVE THE PRESSURE IN THE SYSTEM, FIRST SUPPORT THE UNIT WITH A HOIST OR THE AID OF ANOTHER PERSON. RELIEVE THE PRESSURE AND SLOWLY LOWER THE UNIT. EXERCISE CAUTION TO AVOID INJURY.**

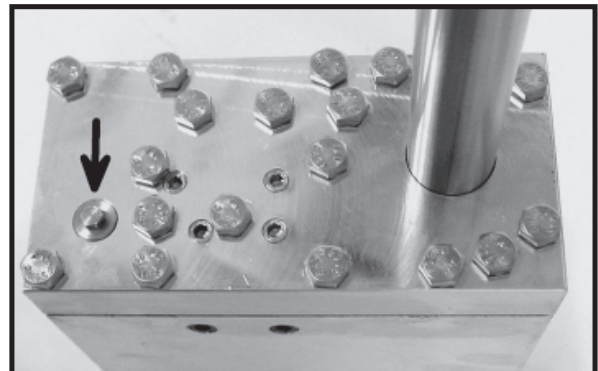
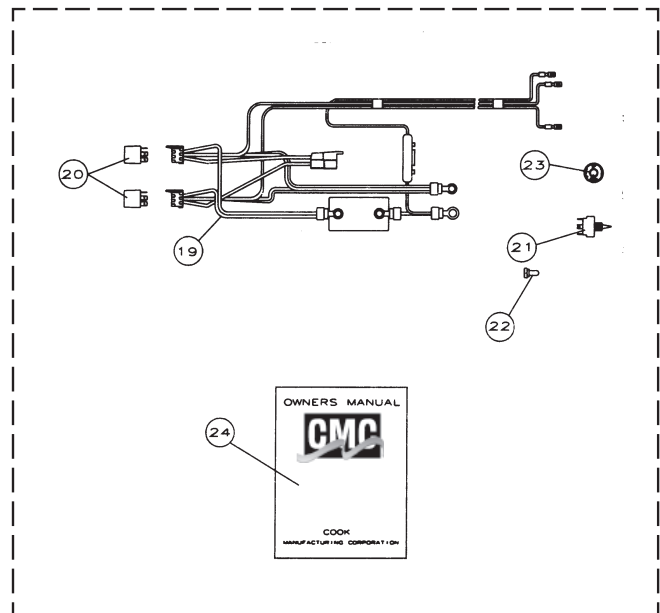
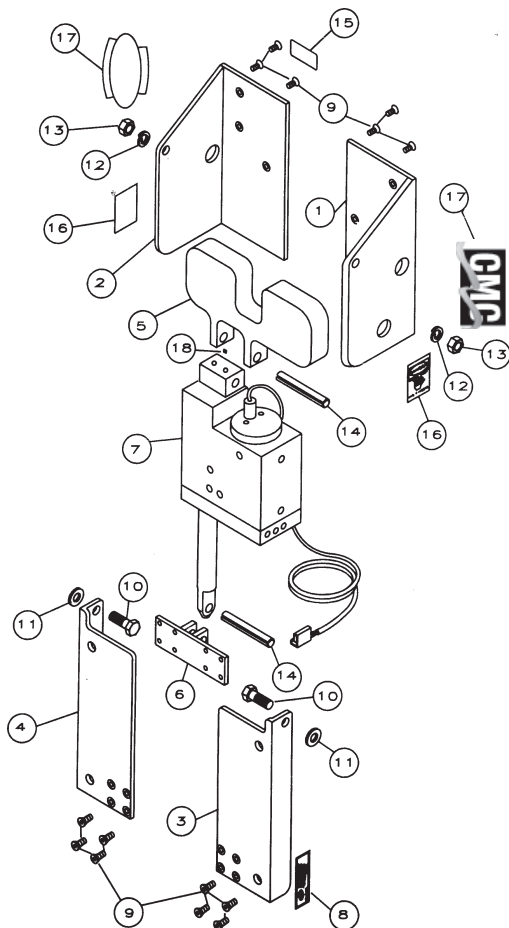

Fig. 26



**ITEM #52100 PT-35 POWER TILT AND TRIM® PARTS LIST**

ITEM#	PART #	DESCRIPTION	QTY. REQ.
1	52010	PORT SIDE MOTOR RAIL	1
2	52020	STARBOARD SIDE MOTOR RAIL	1
3	52030	PORT SIDE TRANSOM RAIL	1
4	52040	STARBOARD SIDE TRANSOM RAIL	1
5	52050	TOP CLEVIS BRACKET	1
6	52060	BOTTOM CLEVIS BRACKET	1
7	7050	MODEL 7050 HYDRAULIC ACTUATOR ASSEMBLY	1
8	52130	SERIAL NUMBER TAG	1
9	52070	1/4" - 20 X 1/2" FLAT HEAD CAP SCREWS 18-8 S.S.	14
10	52150	1/2" - 13 X 1-1/4" HEX HEAD CAP SCREW 18-8 S.S.	2
11	52120	1/8" X 1/2" X 1" NATURAL NYLON FLAT WASHER	2
12	6036	1/2" HELICAL SPRING LOCK WASHER 18-8 STAINLESS STEEL	2
13	7080	1/2" - 13 TWO WAY SELF LOCKING HEX NUT 18-8 S.S. CAD PLATED	2
14	6009	1/2" X 3-1/2" SPRINT PIN S.S.	2
15	52140	WARNING STICKER FOR PT-35	1
16	51222	WATCH YOUR HANDS WARNING LABEL	2
17	52202	TILT AND TRIM DECAL	2
18	6083	1/4" - 20 x 3/16" HEX SOCKET CUP OINT SET SCREW 18-8S.S.	1
19	7014	MAIN WIRE HARNESS FOR P.M. MOTOR	1
20	7122	RELAY	2
21	7123	TOGGLE SWITCH	1
22	7124	TOGGLE SWITCH RUBBER BOOT	1
23	51380	TOGGLE SWITCH PLATE	1
24	52160	PT-35 OWNERS MANUAL	1



## TROUBLESHOOTING

If problems should occur, follow the checklist below step by step. This should eliminate any simple problems that should arise.

### PROBLEM:

The unit will not run in either direction.

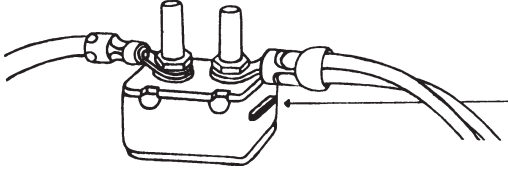

1. Check for dead battery.
2. Reset the circuit breaker at + battery terminal.
3. Check continuity through toggle switch.
4. Check wire continuity from switch to connector.
5. Check for 12 volts at toggle switch, wire labeled +.

### CIRCUIT BREAKER RESET BUTTON

6. If these check well, replace the hydraulic actuator.

Will not run in one direction.

1. Check the toggle switch.
2. Check wire continuity from toggle switch to connector.

Actuator runs but unit does not move up or down.

1. Check hydraulic fluid level.

Unit at up position leaks down to the bottom.

1. Run unit up and down several times. Could have debris in check valve. If this does not correct the problem replace actuator.

Unit at up position and will not come down.

1. Make sure there is no foreign object binding the unit. If there is no foreign object binding the unit, replace the actuator.

Unit will not trim under power or goes up very slowly while not under power.

1. Check with ammeter on + line to see if registering 50 - 60 amps when unit is run to top and is "bogged" down. (Unit will pull 25 - 40 amps during up and down motion).
2. If a smaller gauge wire has been spliced into wire harness, this could be the cause.
3. Check with voltmeter to see if getting 12 volts from battery. Also check it as the PT-35 is running. If voltage drops more than 1 volt, the battery is not supplying enough power.
4. If the actuator "free wheels" and does not leak down, the system is low on fluid or has air in system. See servicing, page 5 for instructions to refill and bleed air.

Unit is in the down position and "locked up" (bogging down).

1. Turn the emergency relief valve (see page 6) counter clockwise 1/2 turn to open. Run the switch up for 5 seconds then down for 5 seconds. Close the emergency relief valve by turning it back 1/2 turn clockwise. Now run the switch up and down. The PT-35 should now raise and lower.



## **LIMITED WARRANTY**

New CMC PT-35 Power Tilt & Trim units are warranted by the manufacturer for one year from date of purchase against defects in workmanship and/or materials in the hydraulic system and five years from the date of purchase against defects in workmanship and/or material in the structure.

This warranty means that only the parts that prove defective during the period of warranty will be repaired or replaced at our option. Cook Manufacturing Corporation will accept only parts returned for warranty pre-paid from initial purchaser and return the repaired or replaced parts freight collect.

Avoid tampering with the Hydraulic Actuator, if a warranty claim is to be made. The warranty is void on any hydraulic actuator returned that shows signs that it has been dismantled or electrical cordset from the motor has been cut.

A return authorization number must be issued from the factory prior to the return of defective parts. Call toll free in the continental United States 1-800-654-3697; outside the United States Call 580-252-1699 to obtain the return authorization.

There are no warranties which extend beyond the description on the face hereof. No one has authority to make any representations concerning the operation of CMC Power Tilt & Trim units except those made in writing by Cook Manufacturing Corporation.

This warranty does not apply for any racing applications or if damage occurs because of accident, improper handling or operation, abuse or misuse.

All liability for any incidental or consequential damage is expressly excluded herefrom.

In order to obtain the benefit of this warranty and agreement, the warranty card found in the centerfold of this manual must be completely filled out and mailed within 30 days to Cook Manufacturing Corporation.

This warranty applies to original ownership only.





acknowledgement

**COOK MANUFACTURING CORPORATION**

3920 SOUTH 13TH • DUNCAN, OKLAHOMA 73533  
(580) 252-1699